









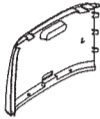

Cabin Litter Box

Component Description

Component	Name	Quantity	Component	Name	Quantity
	Upper Cover	One		Cat Litter Tray	One
	U Shape Cover	One		Stop Block	One
	Side Cover LH	One		Transparency Door	One
	Side Cover RH	One		Connet Clamp	Two
	Rear Cover	One		Front Cover	One
	Activated Carbon	One			

1

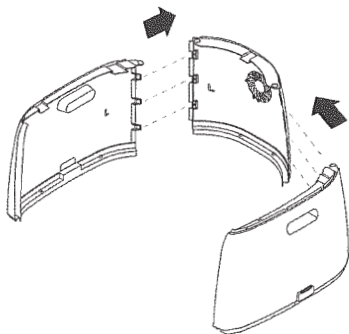

Align the clip structure between Side Cover LH/RH and Rear Cover and then plug tightly.

2

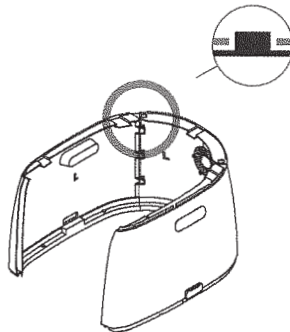

Check the clip status on top side between Side Cover LH/RH and Rear Cover.

3

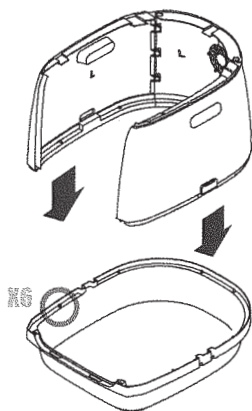

The pin structure on Cat Litter Tray should be inserted to the hole structure on Side Cover and Rear Cover.

4

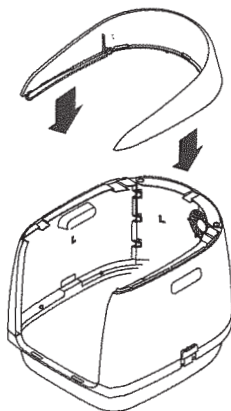

Put U Shape Cover on Side Cover and Rear Cover.

5

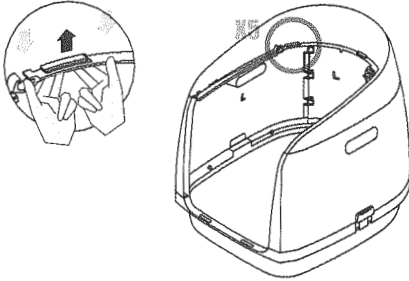

Push the clip structure on Side Cover LH/RH and Rear Cover in vertical direction.

6

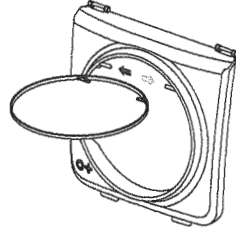

Fix Transparency Door on Front Cover by pin structure.
PS: Concave outward.

7

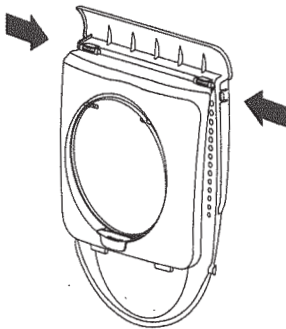

The clip structure on Front Cover is inserted to the spindle structure on Upper Cover.

8

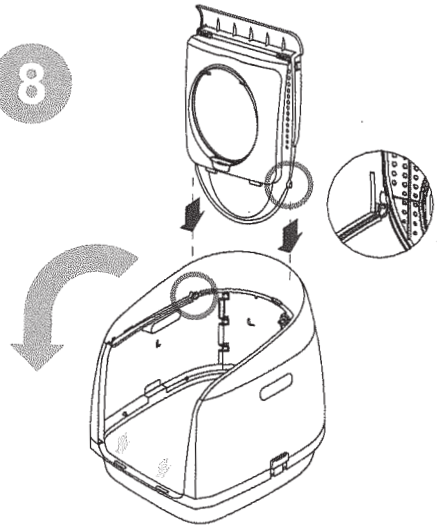

The spindle structure on both side of Upper Cover is inserted to the hole structure on U Shape Cover, and then rotate Upper Cover, insert the pin structure on Front Cover to the hole structure on Cat Litter Tray.

9

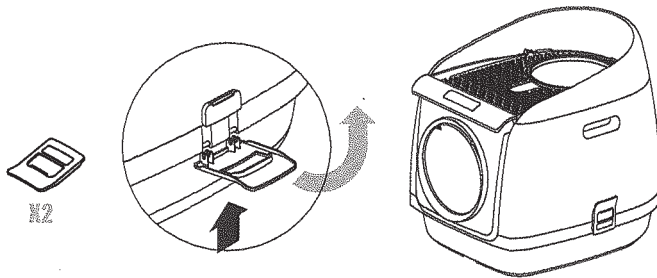

Insert the clip structure on Connect Clamp to the spindle structure on Cat Litter Tray and rotate Connect Clamp to clip on Side Cover LH/RH.

Optional component:

Stop Block.(Before assemble Stop Block,
Please estimate your cats' athletic capacity)

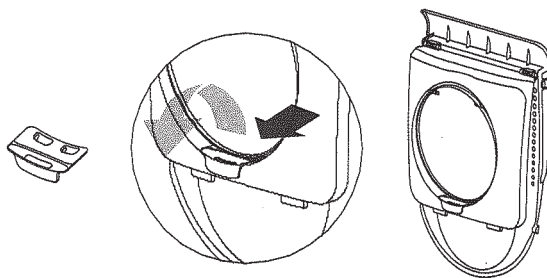

Clip Stop Block on Front Cover.

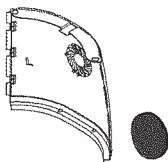

Put the Activated Carbon Felt into the vent of Rear Cover.

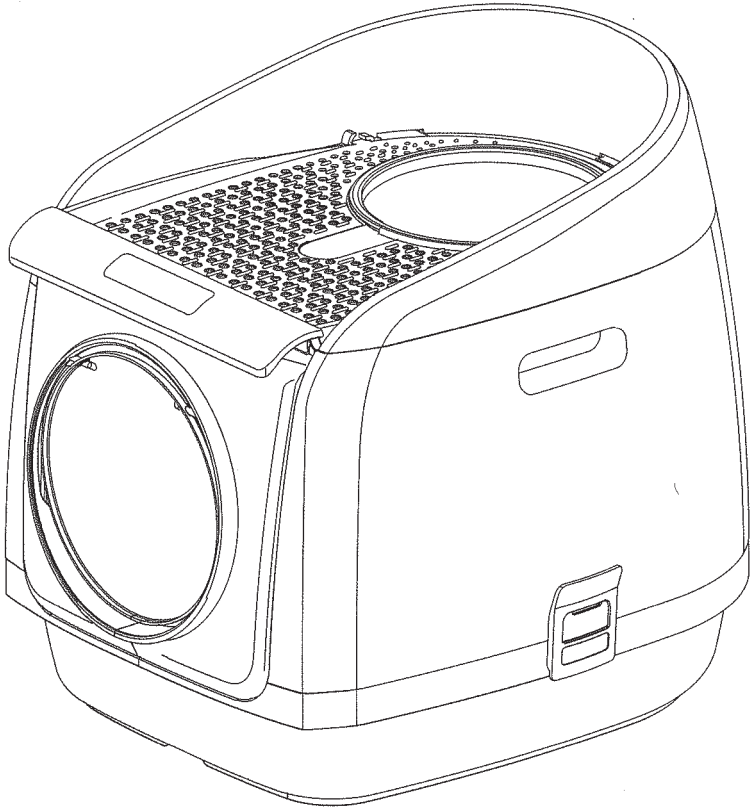

Cabin Litter Box