



AQUARIUM EXTERNAL FILTERS

EF1 / EF2 / EFX

 **Filtres Externes pour Aquarium**

 **Filtri Esterni per Acquario**

 **Filtros Externos para Acuario**

 **Aussenfilter**



EASY PRIMING SYSTEM

MULTI LAYER FILTRATION

TAP SHUT OFF SYSTEM

QUIET OPERATION

EASY TO MAINTAIN



To ensure your new external filter is set up and running correctly, and to prevent any accidental damage or injury, please read and follow the below instructions carefully before using your product.

SAFETY

IMPORTANT! Disconnect the mains electricity supply before attempting any installation / maintenance of any kind. Do not attempt to modify this unit in any way and only use the recommended parts for replacement.

- The external filter should never be run dry as this will cause the unit to overheat and cause permanent damage.
- All connections must be earthed.
- The power cord of this appliance cannot be replaced; if the cord is damaged, the appliance should be discarded. Never cut the cord.
- Do not connect to any voltage other than that stated.
- This filter is suitable for indoor household aquariums only (do not use in exterior locations, swimming pools, ponds, bathrooms etc). Do not place in liquids other than water.
- Do not use with water above 90°F or 30°C.
- Do not carry or pull the unit by its electrical cable.
- Do not use this unit if it has a damaged cord or plug, if it is malfunctioning or it is dropped or damaged in any manner
- Do not yank cord to pull plug from outlet. Grasp the plug and pull to disconnect. Always unplug an appliance from an outlet when not in use.
- Do not attempt to modify this unit in any way and only use the recommended parts for replacement.
- Before installing, maintaining or handling your equipment, or before placing your hands in your aquarium, ensure that the unit is disconnected from the electricity supply.
- Always unplug any electrical devices when not in use.
- Carefully examine your filter after installation. Do not plug in the unit to the mains if there is water on any parts not intended to be wet.



- The power cable must have a drop loop to avoid any condensation build up reaching the mains (see diagram 1). If the plug does get wet, DO NOT unplug the cord. Disconnect the fuse or circuit breaker that supplies power to the appliance. Then unplug and examine for presence of water in receptacle.
- Carefully examine your filter after installation. Do not plug in the unit to the mains if there is water on any parts not intended to be wet.
- If the unit shows any signs of water leakage, disconnect the power supply cord from the wall socket and consult All Pond Solutions or the retailer you purchased this unit from for further advice.
- If the plug or unit does get wet, DON'T unplug the cord. First, disconnect the circuit breaker or fuse that supplies power to the appliance. Next, unplug and inspect for water presence in the receptacle.
- To avoid injury, do not touch hot or moving parts such as, but not limited to, heaters, reflectors, UV bulbs or impellers.

Diagram 1

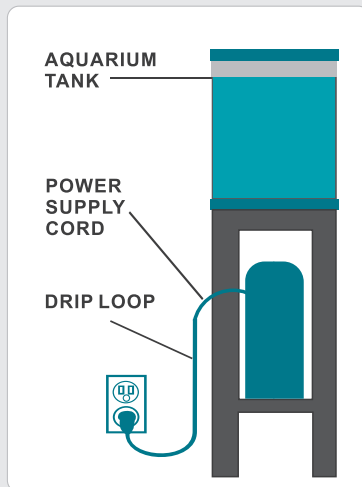

Please note – this appliance can be used by children aged from 8 years and above and persons with reduced physical, sensory or mental capabilities or lack of experience and knowledge, provided they are given supervision and instruction concerning use of the appliance and understand the hazards involved. Children must not play with the appliance. Any maintenance must not be made by children without supervision.



ELECTRIC

This unit comes complete with a generous supply of 3 core cable, however should any additional cable be required, the use of an approved waterproof cable connector with a proper rating is essential. A cord rated for less amperes or watts than the appliance rating may overheat.

Please Ensure: The power supply must be earthed and fused at 3amps. Regularly inspect the cable for damage and deterioration. Consult a qualified electrician if in doubt about any aspects of wiring.

INSTALLATION & USE

Please read the below instructions carefully before beginning to set up your filter. **DO NOT CONNECT THE UNIT TO THE MAINS UNTIL SET UP IS COMPLETE AND UNIT IS FILLED WITH WATER.**

Important installation information:

- The base of the unit must **NOT** be more than 1.4m (4.5 ft) below the tank water level.
- The water level must **NOT** be more than 17cm (7 inches) below the tank rim.
- It is essential to position your external filter **BELOW** your aquarium.
- The green hose must be kept taut with no loops and follow a **STRAIGHT LINE** from the filter to the rim of the aquarium. If the hosing is too long the filter **WILL NOT WORK CORRECTLY.**
- The inlet pipe should **NOT** be positioned too close to an air stone, aeration device or the output valve to avoid reducing the effectiveness of the filter.



Unpack the unit and identify all parts using the parts diagram in this manual.

- 1.** Attach the EF tap to the filter head, pull up the tap handle to allow insertion (1), push the tap into the head tap area (2), fasten the tap into place using the tap handle (3).
- 2.** Unclamp all four head and body clips and separate the filter head from the filter body.
- 3.** Take out the filter media secure plate and pull out the filter media baskets using the handles provided. Using the baskets, rinse your filter media under the tap until it runs clear. Once you have done this you should place the rinsed baskets and filter media back inside the filter with the filter media secure plate at the top. Before replacing the motor head on the filter, fill your filter 3/4 full with water from your aquarium.
- 4.** Place the motor head back on top of the unit.
- 5.** Shut both of the motor head levers down and fasten the buckles to the side of the filter.
- 6.** Check that the EF tap is shut to avoid leakage (lever down), and ensure your pipework is setup as per the Set Up Diagram

Fit your hose to your aquarium so as the inlet hose is fitted to the overflow pipe and the outlet hose is fitted to the spray bar as per the Set Up Diagram. Please ensure your aquarium water level is high enough to cover all inlet and outlet pipework connection points, as otherwise you can let air into the filter system which will stop it from priming properly.

You may need to cut off any excess hosing to ensure the hose is not slack or causes looping. Ensure that the hose follows a straight line from the canister to your aquarium and its intake connection point is approximately 7.5cm (3 inches) below the water line. It is advisable to allow a small surplus before cutting the hose – you can always cut the hose further during final installation. This is extremely important as if the hose is too long, the filter may not operate correctly.

IMPORTANT! – the 'cut' side of the hose must always be connected to the inlet and outlet pipework connection points, NOT to the inlet / outlet tap hose adapters. The cut end of the hosing must also be kept underwater to ensure a watertight seal.



You must also make sure that the strainer on your inlet pipework is at least 7.5cm (3 inches) from the bottom of the tank. If your water intake pipe is too long, you will need to cut the pipe with a hacksaw to the desired length, before replacing the strainer. Once it is correctly positioned, secure the suction cup against the tank glass to hold in place.

7. Once you have your filter in place and its hoses securely attached to your aquarium you are ready to prime the filter. Using the palm of your hand, push the blue button directly on top of the motor head as far down as it will allow you to and repeat if necessary, until the output hose has filled with water. You are now ready to plug your external filter in.

IMPORTANT! – to prevent any damage to you unit, ensure the canister is completely full of water before the unit is switched on.

Water should flow constantly from the output – if it does NOT, check to confirm the following:

- The canister cover is fully closed
- Any kinks or slack in the hose have been removed
- The water level in the tank is not more than 17.5cm (7 inches) below the tank rim
- The base of the unit is not more than 1.4m (4.5 ft) below the tank water level
- There is no air bubbling or water escaping from where the water intake or return pipes are connected to the hose
- The hose adapters are fixed securely into the filter motor head.
- The inlet pipe is securely attached to the aquarium wall with the suction cup

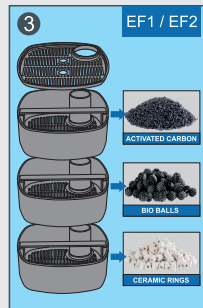
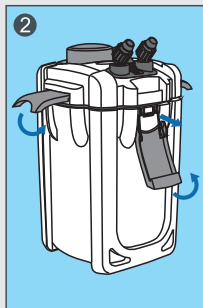
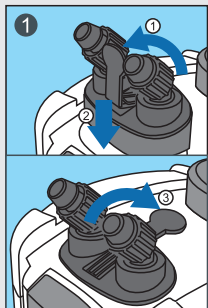

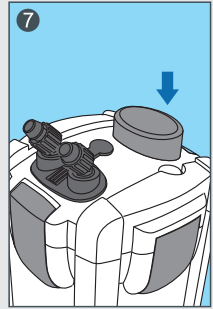
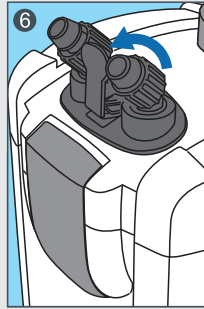
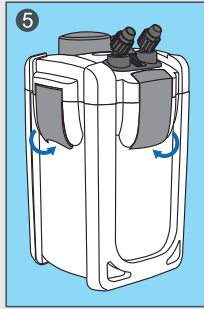
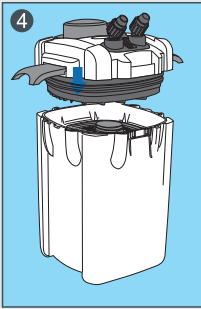

SET UP DIAGRAM

Position the EF adjacent to your fish tank for maximum flow
Water must be 1-2cm above inlet bend pipe

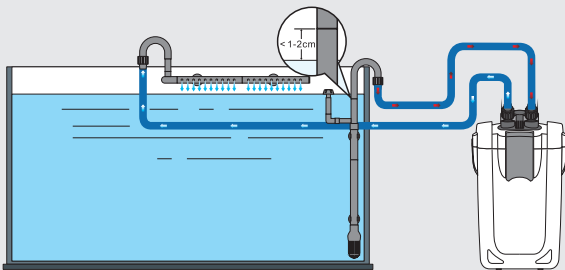

Recommended set up beneath your tank

MAINTENANCE

To ensure optimal performance and that your unit functions correctly, regular maintenance is essential. Failure to do so may result in damage to your unit and may invalidate your warranty.

We recommend that a regular cleaning and maintenance schedule is followed to ensure responsible fishkeeping. Depending on water volume and stocking levels, regular cleaning of the filter media, foams, impeller, inlet/outlet pipework during a 10-25% water change will help ensure that the product works efficiently and the aquarium remains healthy.



For further maintenance guidance, please see the table and additional information below:

	1 MONTH	3 MONTHS	6 MONTHS	ANNUALLY
Impeller	Clean & Inspect			Replace
Ceramic Shaft	Clean & Inspect			Replace
All Pipework	Clean & Inspect			
Green Hose				Clean & Inspect
O-Rings	Clean & Inspect	Lubricate & Clean		Replace
Filter Foams & Other Media	Clean & Inspect		Replace	
Carbon	Replace*			

* Carbon should be replaced every 2-3 months.

O-rings

It is vital that O-rings are regularly inspected and replaced as the rubber watertight seal will perish over time, which may cause your canister to leak. Before replacing your o-rings, ensure they are well lubricated.

Filter Maintenance

IMPORTANT! If the unit is switched off ensure the outlet/unit tap is closed.

In general, it is recommended to disconnect your filter and clean the pipes, impeller and filter media monthly. Pipework will become blocked with waste and protein slime over time, so regular cleaning is important for optimal performance.

The frequency of how often you will need to clean and inspect your unit of course will depend on a lot of factors like how dirty the water is when you first start using an external filter, the volume of your water and also how many fish you have. How often you feed your fish and how long your lighting is on for will also affect how quickly your aquarium water gets dirty and will need to be taken into consideration when planning how often to clean your external filter.



Impeller and Shaft

A clogged impeller is often the primary cause of all filter faults, so it is extremely important to clean and inspect your impeller every month to ensure it is functioning correctly and remove any debris. Keeping the impeller clean will improve the performance of your filter and lengthen the life of the motor. The impeller itself is a perishable part and will be subject to wear and tear overtime. As a result, it is also very important to replace your impeller and ceramic shaft annually.

To gain access and clean your impeller and shaft open up the filter (disconnect the pipes and turn the filter off). You should be able to then see the impeller through an impeller guard in the middle of the motor head. Turn the impeller guard and pull it away and out of the motor head - you will then have full access to the impeller and shaft.



EF1 /EF2



EFX

Simply wash this and clean this with your aquarium water (from a water change) - whilst doing this you will be able to check that the impeller and shaft are both in good condition. When returning this to the motor head ensure this is seated correctly with the two rubbers on either end of the shaft (sometimes the rubbers stay in the holes that they fit into and will not be obviously evident when first removing the impeller and shaft).

Note: Handle the ceramic shaft with care as this can break very easily during the cleaning process.

Filter Media

The filter media provided with your external filter and there positioning within the media trays are designed to give complete and optimum filtration for your tank:



BOTTOM MEDIA TRAY	Ceramic Rings	Mechanic Filtration	Removes small waste particles from the water.
MIDDLE MEDIA TRAY	Bio Balls	Biological Filtration	Creates environment for nitro-bacteria to cultivate and help oxygenate the water.
TOP MEDIA TRAY	Activated Carbon	Chemical Filtration	Removes soluble waste, chlorine and cultivates nitro-bacteria.

IMPORTANT! Always use water from your fish tank to clean your filter media. Do not use mains water or any cleaning products to clean your media.

The suggested filter media order is ceramic rings at the bottom, bio balls in the middle and active carbon at the top with one biochemical cotton in each tray, providing mechanical, biological and chemical filtration as the water flows up through the media baskets.

Please remember to change your activated carbon at least every 2-3 months as after this time it is possible that the carbon can have a negative effect on your aquarium as the very waste it removes can be released from the carbon back into the aquarium.

When cleaning mechanical or biological media, **NEVER** rinse with tap water or use any soap or detergent, only your aquarium water. The best time to rinse your filter foams, bio balls and ceramic rings through is when doing a 10 / 20% water change as you can use this water to wash the media through.

When replacing media in your filter, do not replace more than 50% of your media at once. This is to ensure that the nitrifying bacteria present in the old media are able to repopulate in the newly added filter media.

Draining Your Filter

Should you need to drain your filter for maintenance or repair purposes, please follow the steps below:

1. Close the inlet / outlet tap by lifting the lever all the way up. This seals off the input and output hosing connections, keeping the vacuum needed in order to restart the filter without priming.



- 2.** Unplug the power cord from the mains.
- 3.** Remove the hose adapter by lifting the hose adapter securing buckle and pulling the adapter out of the motor head.
- 4.** Holding the canister at the base, move it to a flat stable surface near a sink or other drain. (Be sure to hold upright to avoid spillages.)
- 5.** To open the unit, unfasten the 2 buckles that are situated at the front and back of the filter then lift the 2 levers that are attached to the left and right sides of the motor head. On doing this the motor head will lift away from the unit. Set aside.
- 6.** Holding the media baskets in place, tilt the canister over the sink or drain, and pour out as much water as possible.
- 7.** Your media and foams will be saturated with water. Lift the filter media baskets out of the canister and place them in your sink or a large bucket.
- 8.** Rinse the inside of the canister with clear aquarium water. NEVER use tap water, or soap or detergents, when cleaning your unit or rinsing media.
- 9.** Rinse the inside of the priming cylinder with clear aquarium water. Make sure no debris is trapped inside the cylinder.
- 10.** When you are ready to reconnect your filter, reinsert the filter media trays and reposition beneath your aquarium. Before replacing the motor head on the filter, fill your filter 3/4 full with water from your aquarium. Place the motor head back on top of the unit, shut both of the motor head levers down and fasten the buckles to the side of the filter. Fit the hose adapter back into the motor head and re-fasten it using the securing buckle.
- 11.** Top up your aquarium tank water level from any water used.
- 12.** Reconnect the power cord to the mains.



SPECIFICATION

MODEL	EF1	EF2	EFX
FLOW RATE	1000 L/H	1400 L/H	2000 L/H
HOSE OUTSIDE DIAMETER	20mm / 0.8"	20mm / 0.8"	25mm (1")
HOSE INSIDE DIAMETER	15mm / 0.6"	15mm / 0.6"	18mm (0.7")
HOSE LENGTH	1.8 Metres x 2	1.8 Metres x 2	1.8 Metres x 2
WATER VOLUME	8 Litres (Approx)	12 Litres (Approx)	20 Litres (Approx)
HEIGHT MAX	1.4 Metres	2.0 Metres	2.5 Metres
VOLTAGE	220-240v	220-240v	220-240v
POWER	24w	30w	45w
DIMENSIONS	395mm x 232mm x 232mm	440mm x 258mm x 258mm	490mm x 290mm x 290mm



PARTS DIAGRAM

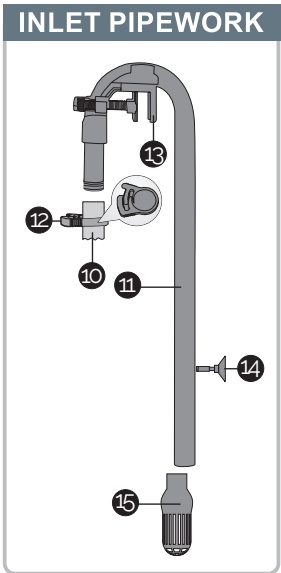
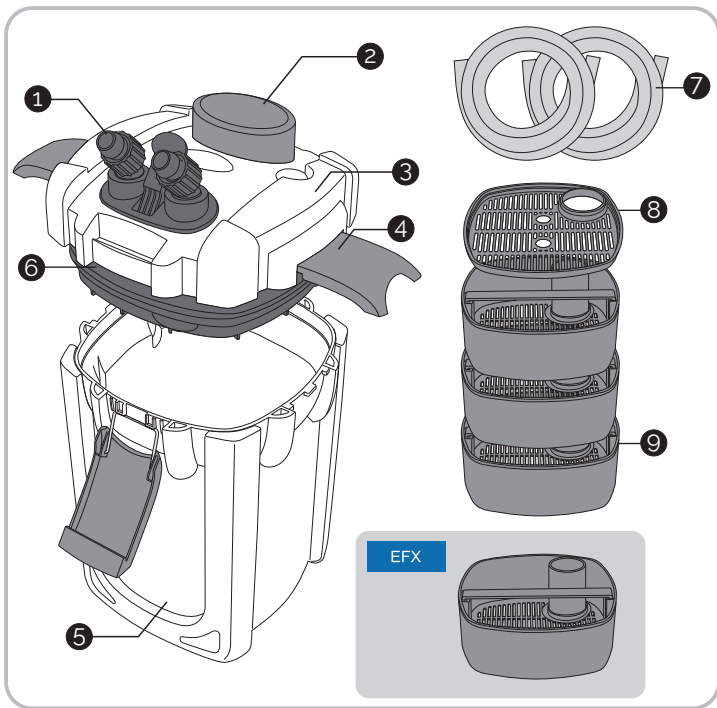

OUTLET PIPEWORK

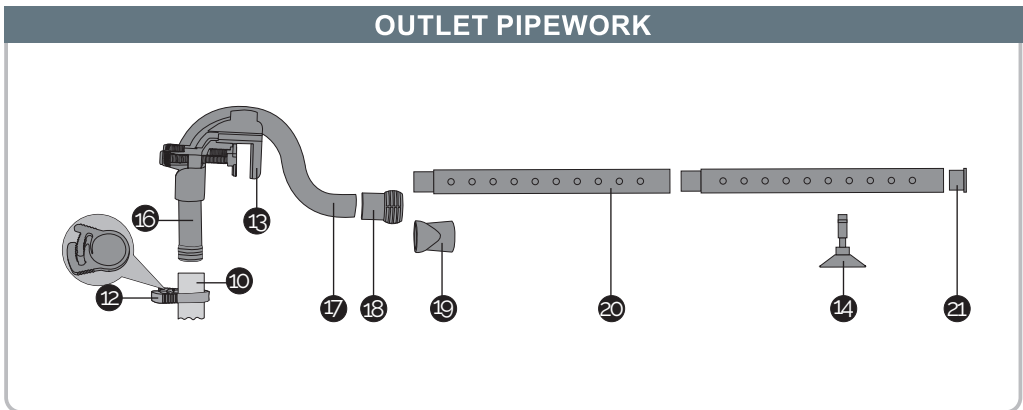

1	INLET/OUTLET TAPS & O-RING'S	6	HEAD O-RING	11	OVERFLOW PIPE FOR WATER INTAKE	16	OVERFLOW PIPE FOR WATER RETURN
2	PRIMING BUTTON	7	HOSE (1.8M X 2)	12	HOSE FASTENING CLIP	17	OUTLET PIPE
3	FILTER HEAD	8	MEDIA SECURE PLATE	13	GLASS FIXING CLAMP	18	OUTLET NUT
4	HEAD/BODY CLIPS	9	FILTER MEDIA BASKETS	14	SUCTION CUPS	19	OUTLET ADAPTER - OPTIONAL TO SPRAY BAR
5	FILTER BODY	10	GREEN HOSE	15	STRAINER	20	SPRAY BAR
						21	SPRAY BAR END CAP



No Filter Operation / Water Flow

- Always ensure the power has been turned on.
- Check that your impeller and shaft are seated correctly and not damaged in any way.
- Ensure the impeller is free of any type of blockage and can rotate freely inside the motor head.
- Check cable for damage - if damage is evident, unplug the unit and do not use the EF. Do not attempt to fix, consult an electrician or other qualified person. Replace fuse if necessary.
- Check all hosing (part 7) and pipework are connected correctly, air tight and unrestricted.
- Check the EF filter body (part 5), filter media, hosing (part 7) and all pipework for a build up of restrictive waste and clean if required.

Noisy Operation

- Check that your impeller and shaft are seated correctly and not damaged in any way.
- Ensure the impeller is free of any type of blockage and can rotate freely inside the motor head.

Priming Problems

If air remains trapped in the system after initial setup, please restart the process and follow these guidelines:

- Check all hosing and pipework is connected correctly, air tight and unrestricted.
- Reinsert the Inlet / Outlet tap (part 1) to be sure it is securely installed and set to open (lever down).
- Ensure all Inlet / Outlet pipework connection points are fully submerged whilst priming.
- Fill the EF filter body (part 5) with aquarium water, this will aid the priming of the EF.
- Prime the EF without the surface skimmer (part 15) attached - this can be re-attached after priming.
- Ensure the EF filter body (part 5) is not over stocked with media and foam as this can restrict water flow and affect the priming function.

The Water In My Aquarium Is Dirty

Causes:

- The beneficial bacteria have not yet established in your new filter.
- Your filter is not the correct size for your aquarium set up.
- You have too many fish for your size filter.
- Your filter media may be dirty.

Solutions:

- Your fish tank can take up to 3 weeks to successfully cycle. You may also want to add a bacteria start treatment to your tank to speed up this process.
- You may need to upgrade to a larger filter.
- For reference, you should allow 1 gallon of water per 1 inch of fish in your aquarium.
- Follow the instructions in the maintenance section above.
- If you have not yet done so, you may also need to carry out more regular water changes in your tank.

No Water Is Coming Out Of My Filter

Causes:

- The impeller is blocked - please refer to the impeller maintenance section above.
- There is no water in the filter body
- The filter is not switched on.
- The inlet pipe is clogged.

Solutions:

- Use a small jug and scoop some water from the surface of your tank and pour into the filter body.
- Check your filter is plugged into the mains and is switched on.
- Remove the filter from your tank and clean the inlet pipe.



COMMON AQUARIUM QUESTIONS

Why Is My Aquarium Water Cloudy?

Causes:

- **Bacterial blossom** - As the new aquarium goes through the initial break-in cycle, the water can become cloudy or at least a little hazy. It might take several weeks to establish beneficial bacterial colonies that are able to clear waste from the water. Over time, that cloudiness will resolve itself. Decaying plants or excess food that remains uneaten can also cause the cloudy water seen in bacterial bloom. Keep the aquarium clean by removing any decaying plants and uneaten food, vacuuming the gravel regularly, and performing partial water changes. It is also a good idea to invest in a UV steriliser, which simply kills the microorganisms creating the cloudy aquarium water problem and helps to control algae issues.
- **Gravel residue** - If the water is cloudy immediately or within an hour or two of filling the tank, it's probably due to insufficiently washed gravel. Drain the tank and rinse the gravel until the water runs clear. That should resolve the problem.
- **Dissolved constituents** - if washing the gravel doesn't solve the problem, the next most likely cause of cloudy water in a newly filled tank is a high level of dissolved constituents, such as phosphates, silicates, or heavy metals. If you test the water, you'll likely find that the pH is high (alkaline). In these cases, treating the water with conditioners will often resolve the problem.

Other things to try:

- Reduce feeding. Overfeeding introduces a lot of organic waste and is one of the main causes for cloudy water problems.
- Do not perform large water changes as they can severely affect the balance of the aquarium leading to a further deterioration of the water quality.
- A severely overstocked aquarium will result in excess waste so consider your fish population. We recommend to not exceed 1 inch of fish per 3.7 litres of aquarium water.

Why Is My Aquarium Water Green?

Causes:

- **Too much light** - Reduce the amount of time the lights are on, and move the aquarium to a location out of direct sunlight. This will reduce the photosynthesis that allows the algae to grow.



- **Phosphates** - phosphates result from decaying matter (e.g. fish food) and from the water source. If your water naturally has a high level of phosphate, you will need to use a phosphate remover to treat it after water changes. You may also consider reducing the amount of food you give your fish.
- **Nitrates** - As the amount of fish waste rises so do the nitrates. Make sure to perform regular water changes, check your filter is clean and adequate for your aquarium size and do not overstock it.

Other things to try:

- Use a UV water steriliser. Algal cells are damaged by the harmful UV light so continuous use should ensure clear water at all times.



WARRANTY

The All Pond Solutions external filter range is guaranteed against defects in material or workmanship under normal aquarium usage and comes with 24 months warranty for all electrical parts. The warranty period commences from the date of purchase.

If you require support on how to use your unit, replacement parts or if your filter develops a fault during the warranty period, please contact the supplier of your unit.

Non-replaceable, non-perishable and non-serviceable parts will be repaired or replaced free of charge, once the unit is returned with all components along with a valid proof of purchase and postage paid. We reserve the right to replace or repair the unit at our discretion.

Please be aware that perishable parts that are subject to normal wear and tear, such as impellers, impeller covers, motor seals and UV bulbs, are not covered by your warranty and a charge may be required for replacements of these.

This warranty does not apply to any unit that has been subjected to misuse, accidental damage, negligence, tampering or customisation. It does not apply to units which have been assembled incorrectly, improperly maintained, or where the instructions and safety information in this manual has not been followed correctly.

No liability is assumed with respect to loss or damage to livestock or personal property irrespective of the cause thereof.

Please ensure that only genuine All Pond Solutions components are used when completing a replacement or repair. Spare parts are available at our official website or from your local supplier.

Before returning your unit under warranty terms, check that all setup and maintenance instructions have been correctly followed. If you are in doubt, please contact your local aquatic retailer for further advice before returning the product.

This does not affect your statutory rights.



IMPORTANT! Débranchez l'alimentation électrique du secteur avant toute tentative d'installation / de maintenance ou de manipulation de toute nature.

- Filtre Externe (filtre extérieur) ne doit jamais fonctionner à sec car cela pourrait causer une surchauffe extérieure et des dégâts permanents.
- Ne pas essayer de modifier cet appareil en aucune façon et utiliser uniquement les pièces recommandées pour le remplacement.
- Toutes les connexions doivent être mises à la terre.
- Ne jamais se connecter à toute tension autre que celle indiquée.
- Ne jamais utiliser aucun liquide autre que de l'eau.
- Ne pas utiliser avec de l'eau au-dessus de 90F ou 30C.

Veillez Noter: Cet appareil n'est pas destiné à être utilisé par des enfants de moins de 8 ans et des personnes (y compris des enfants) dont les capacités physiques, sensorielles ou mentales sont limitées ou qui manquent d'expérience et/ou de connaissances, à moins qu'elles ne soient surveillées par une personne chargée de la sécurité ou qu'elles n'aient reçu de sa part des instructions quant à l'utilisation de l'appareil d'une manière sécuritaire. Les enfants doivent être surveillés afin de s'assurer qu'ils ne jouent pas avec l'appareil. Le nettoyage et l'entretien après l'usage ne doivent pas être faits par des enfants sans surveillance.

ÉLECTRIQUE

Le filtre extérieur est livré au complet avec une bonne quantité de câble à trois entrées, cependant, dans l'éventualité où un câble supplémentaire deviendrait nécessaire, il est très important de n'utiliser qu'un connecteur de câble étanche approuvé dans les normes.

- Utilisez toujours une prise reliée à la terre pour le branchement, avec une tension de réseau à 3 ampères.
- Inspecter régulièrement le câble pour vérifier les éventuels défauts et la détérioration.
- Consultez un électricien qualifié en cas de doute à propos de tous les aspects de câblage.

- ❶ Attachez le robinet du filtre extérieur à la tête du filtre, tirez vers le haut la poignée du robinet pour permettre l'insertion (1), poussez le robinet dans l'espace tête du robinet (2), fixez le robinet en place en utilisant la poignée du robinet (3).
- ❷ Débloquez les quatre clips de la tête et du corps et séparez la tête du filtre du corps du filtre.
- ❸ Bien laver tous les composants du milieu du filtre jusqu'à ce que l'eau soit claire pour éviter la libération d'excès de poudre / poussière dans votre réservoir. Remplissez le filtre extérieur aux trois-quarts avec de l'eau d'aquarium.
- ❹ Remontez la tête de filtre sur le corps du filtre.
- ❺ Assurez-vous bien que tous les quatre clips de tête et du corps soient solidement fermés.
- ❻ Vérifiez que le robinet du filtre extérieur est fermé pour éviter les fuites (levier vers le bas), et assurez-vous que votre tuyauterie a une configuration similaire au schéma de montage ci-dessous.
- ❼ Amorcer le filtre extérieur en appuyant sur le bouton d'amorçage, appuyez sur la touche avec la paume de votre main et continuez à appuyer jusqu'à ce que tous les tuyaux soient remplis d'eau.
- ❽ Branchez le filtre extérieur à la source d'alimentation pour le mettre en marche.

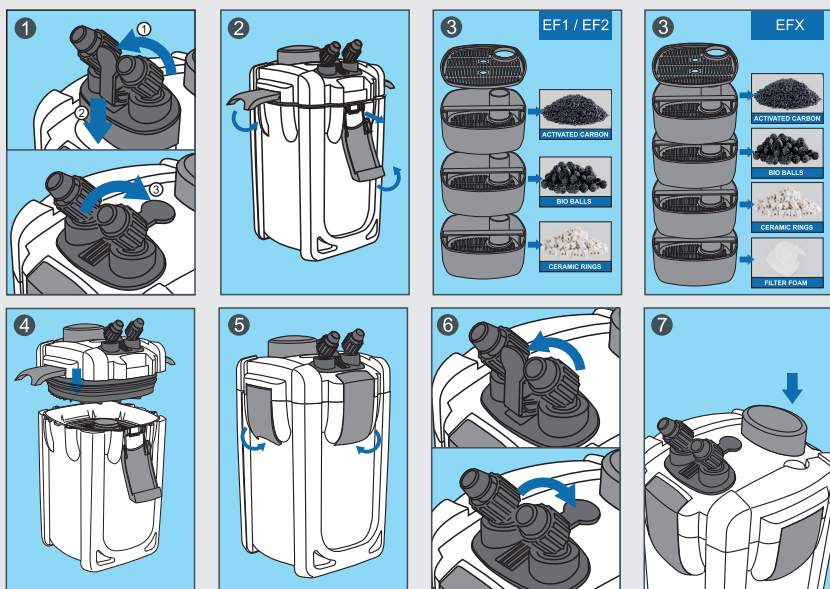

Nous recommandons un entretien régulier et un programme de nettoyage suivi pour assurer une aquariophilie responsable. Selon le volume de l'eau et les niveaux de stocks, le nettoyage régulier des agents filtrants, des mousses, de la roue, de la tuyauterie d'entrée / sortie lors d'un changement de 10 à 25% de l'eau aideront à optimiser l'efficacité de votre filtre et à garder votre aquarium propre et sain.

La pompe et la tige

Pour accéder à la pompe et la tige:

- ❶ Tirez la poignée du robinet du filtre extérieur pour arrêter l'arrivée d'eau au filtre extérieur, tirez le robinet du filtre extérieur loin de la tête de filtre.
- ❷ Desserrer les quatre clips tête et corps et séparer la tête du filtre du corps du filtre.
- ❸ Dévisser et enlever le bouchon de la pompe située sur le dessous de la tête du filtre et retirer doucement la pompe et la tige.

Vérifiez l'état de la roue et de l'arbre et nettoyez avec l'eau de votre aquarium. Nettoyez l'intérieur du logement de la roue et assurez-vous que les caoutchoucs de l'arbre sont en place aux deux extrémités avant de remplacer.

Si la roue et l'arbre ont des dégâts visibles, contactez votre détaillant local pour acheter des remplacements. Inversez les étapes ci-dessus pour remplacer.



EF1 /EF2



EFX

Système de filtration

Nous vous recommandons d'installer le support de filtre fourni dans l'ordre suivant: bagues en céramique dans le panier inférieur, boules bio dans le panier moyen et charbon actif dans le panier supérieur.

Les anneaux en céramique et les balles bio sont de longue durée et peuvent être nettoyés avec l'eau de l'aquarium dans le cadre d'un programme de nettoyage régulier. Nous recommandons de remplacer le charbon actif au moins tous les 3 à 6 mois.

PIÈCES DU DIAGRAMME

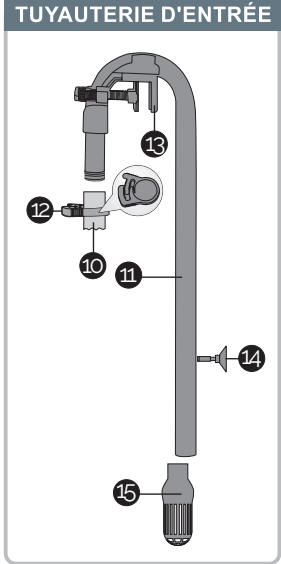
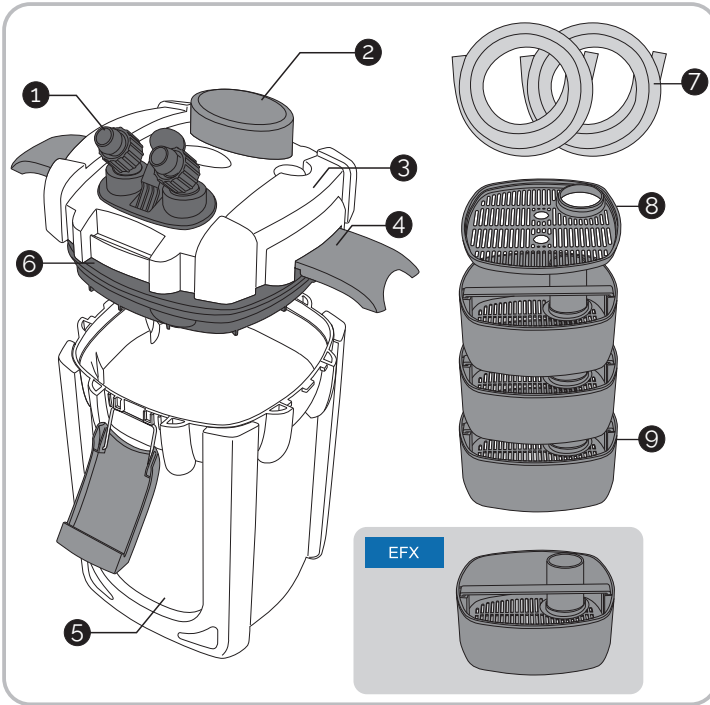

TUYAUTERIE DE SORTIE

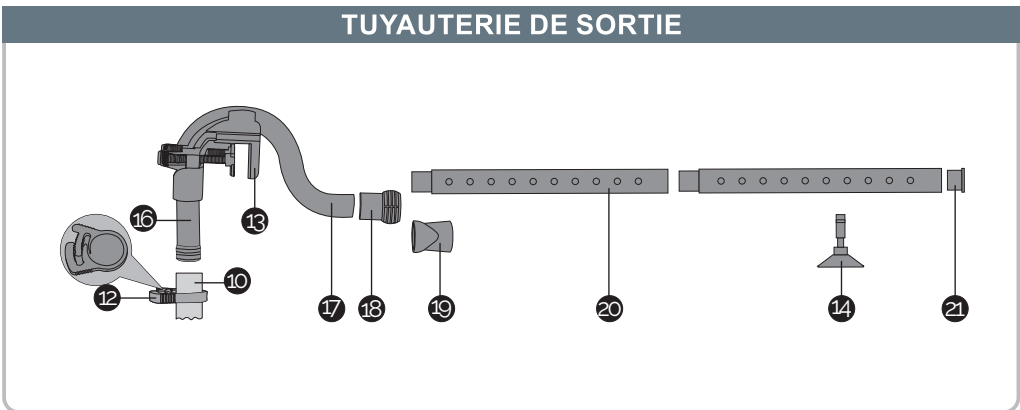

1	ROBINETS & ANNEAUX - ENTREE/SORTIE	6	ANNEAU DE TETE	11	TUYAU DE DÉBORDEMENT POUR ENTRÉE D'EAU	16	TUYAU DE DÉBORDEMENT POUR RETOUR D'EAU
2	BOUTON D'AMORCAGE	7	TUYAU (1,8X2)	12	CLIP DE FIXATION DE TUYAU	17	TUYAU DE SORTIE
3	TETE DE FILTRE	8	PLAQUE FIXE DES MATÉRIaux	13	PINCE DE FIXATION DE VERRE	18	ECROU DE SORTIE
4	CLIP TETE/CORPS	9	PANIER FILTRE DES MATÉRIaux	14	VENTOUSES	19	ADAPTATEUR DE SORTIE - EN OPTION POUR BARRE DE PULVÉRISATION
5	CORPS DU FILTRE	10	TUYAU VERT	15	CRÉPINE	20	BARRE DE PULVÉRISATION
						21	EMBOUT DE LA BARRE DE PULVÉRISATION



Le Moteur ne fonctionne pas

- 1 Vérifiez que l'appareil est bien connecté et allumé.
- 2 Vérifiez que la roue est correctement installée, en bon état et que rien ne la bloque.
- 3 Vérifiez le câble que le câble n'est pas défectueux – et s'il y a un dommage évident, débrancher et ne pas utiliser le filtre extérieur. N'essayez pas de le réparer vous-même, Donnez l'appareil pour toute réparation à un électricien ou du personnel qualifié et autorisé.
- 4 Remplacez le fusible si nécessaire.

Problèmes d'amorçage

Si de l'air reste piégé dans le système après l'installation initiale, veuillez redémarrer le processus et suivre ces lignes directrices:

- 1 Vérifiez que toute arrivée d'eau et la tuyauterie sont correctement connectées, étanches à l'air et sans blocage.
- 2 Remettez l'entrée / sortie du robinet (partie 1) pour être sûr qu'il est correctement installé et configuré pour ouvrir (levier vers le bas).
- 3 Assurez-vous que tous les points de raccordement de la tuyauterie d'entrée / sortie sont complètement immergés pendant l'amorçage.
- 4 Remplir le corps du filtre extérieur (partie 5) avec de l'eau de l'aquarium, cela aidera l'amorçage du filtre extérieur.
- 5 Démarrez le filtre extérieur sans l'écumoire de surface (partie 15) attachée- Elle peut être remise en place après l'amorçage.
- 6 Assurez-vous que le corps du filtre extérieur (partie 5) ne soit pas trop rempli de matériau et de mousse car cela peut restreindre le débit d'eau et affecter la fonction d'amorçage.

Bruit excessif

- 1 Vérifiez que la pompe du filtre extérieur soit correctement installée, en bon état et exempte de blocage.
- 2 Suivez le processus des « problèmes d'amorçage » ci-dessus.

Débit d'eau restreint

- 1 Vérifiez que la pompe du filtre extérieur soit correctement installée, en bon état et exempte de blocage.
- 2 Vérifiez tout jet d'eau (partie 7) et que la tuyauterie soient correctement connectés, étanche à l'air et sans restriction.



- ③ Vérifiez le corps du filtre extérieur (partie 5), les systèmes de filtration, le tuyau (partie 7) et toute la tuyauterie pour une accumulation de déchets restrictive et nettoyer si nécessaire.

Avez-vous plus de questions?

Contactez le détaillant qui vous a vendu ce produit All Pond Solutions pour plus d'assistance.

CARACTÉRISTIQUES

MODEL	EF1	EF2	EFX
DÉBIT	1000 L/H	1400 L/H	2000 L/H
DIAMÈTRE EXTÉRIEUR DU TUYAU	20mm / 0.8"	20mm / 0.8"	25mm (1")
DIAMÈTRE INTÉRIEUR DU TUYAU	15mm / 0.6"	15mm / 0.6"	18mm (0.7")
LONGUEUR DU TUYAU	1.8 Metres x 2	1.8 Metres x 2	1.8 Metres x 2
VOLUME D'EAU	8 Litres (Approx)	12 Litres (Approx)	20 Litres (Approx)
HAUTEUR MAX	1.4 Metres	2.0 Metres	2.5 Metres
TENSION	220-240v	220-240v	220-240v
PUISSANCE	24w	30w	45w
DIMENSIONS	395mm x 232mm x 232mm	440mm x 258mm x 258mm	490mm x 290mm x 290mm

METTRE EN PLACE DIAGRAMME

Water must be 1-2cm above inlet bend pipe

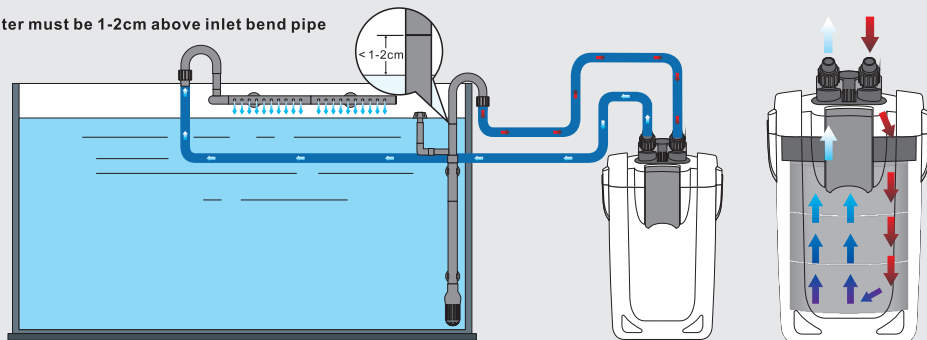

Position the EF adjacent to your fish tank for maximum flow



La gamme de filtre extérieur d'All Pond Solutions est fournie avec une garantie pour les pièces dans le cas d'une faute réelle ou défaillance mécanique pour une période de 24 mois à compter de la date d'achat. Nous déclinons toute responsabilité pour l'usure, les dommages accidentels ou des problèmes découlant de la modification ou de l'utilisation abusive. Les pièces de rechange sont disponibles sur notre site officiel ou chez votre fournisseur local. Veuillez-vous assurer que seuls les composants d'origine d'All Pond Solutions sont utilisés lors d'un remplacement ou d'une réparation.



ATTENZIONE! Disinserire sempre la spina di alimentazione prima di eseguire qualsiasi intervento di installazione, manutenzione o prima dell'utilizzo.

- Non azionare il filtro esterno EF a secco per evitare il surriscaldamento dell'unità o un danno permanente.
- Non provare a modificare in alcun modo l'apparecchio ed usare esclusivamente le parti indicate per la sostituzione.
- Il collegamento alla rete elettrica deve avvenire con prese con messa a terra.
- Non connettere ad un voltaggio differente da quello indicato.
- Immergere esclusivamente in acqua.
- Utilizzare in acqua a temperature non superiori ai 90F o 30C.

ATTENZIONE! L'apparecchio può essere utilizzato da bambini di età superiore agli 8 anni e persone con capacità fisiche, sensoriali e mentali ridotte; da persone che manchino di esperienza e conoscenza dell'apparecchio, nel caso in cui essi siano sotto la supervisione di un esperto o abbiano ricevuto le necessarie istruzioni riguardo l'utilizzo sicuro dell'apparecchio e siano a conoscenza dei possibili rischi. I bambini non devono giocare con l'apparecchio. I bambini non devono occuparsi della pulizia e della manutenzione senza supervisione.

APPARECCHIO ELETTRICO

Il filtro è fornito complete di cavo a 3 conduttori. Se è necessario un cavo di prolunga è necessario un connettore per cavo resistente all'acqua.

- Il collegamento alla rete elettrica deve avvenire con prese a messa a terra, alimentate a 3 ampere.
- Controllare regolarmente il cavo, per verificare che non abbia subito danni o sia deteriorato.
- Consultare un elettricista qualificato in caso di dubbi relativi al circuito elettrico.

- ❶ Collegare il bocchettone alla testata del filtro, sollevare la leva del bocchettone per l'inserimento (1), inserire il bocchettone nell'apposita area (2), agganciare il bocchettone usando l'apposita leva (3).
- ❷ Sganciare i 4 ganci della testata e del corpo del filtro per separare le due parti.
- ❸ Sciacquare tutte le parti del filtro fin quando l'acqua risulti pulita, per evitare che vi siano impurità o polvere all'interno del serbatoio. Riempire il filtro per 3/4 con l'acqua dell'acquario.
- ❹ Riunire la testata al corpo del filtro.
- ❺ Assicurarsi che i ganci siano chiusi saldamente.
- ❻ Controllare che il bocchettone del filtro sia chiuso per evitare fuoriuscite (leva verso il basso), ed assicurarsi che il tubo sia installato come nella figura.
- ❼ Innescare il filtro tramite il pulsante di innesco, premere il pulsante con il palmo della mano fin quando tutti i tubi siano pieni d'acqua.
- ❽ Accendere il filtro.

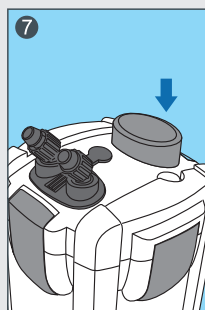
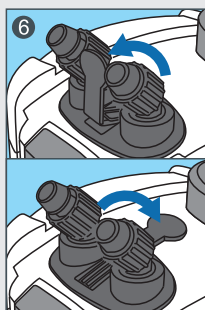
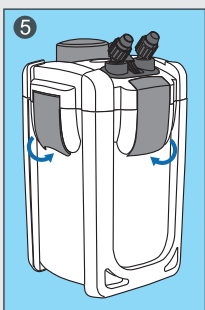
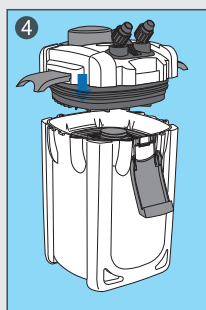
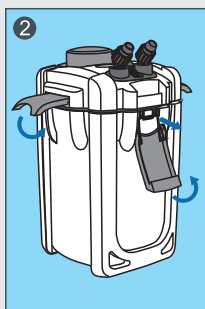
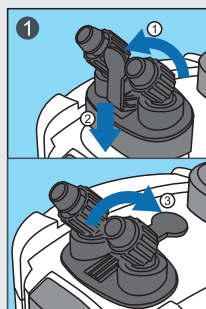

Si raccomandano pulizia e manutenzione del filtro a scadenze regolari per una corretta acquariofilia. A seconda del volume dell'acqua e della quantità di pesci, è consigliabile una corretta pulizia dei materiali filtranti, delle schiume, della girante e del tubo di entrata/uscita dell'acqua durante il cambio di una percentuale di acqua pari al 10-25%; questo può essere utile al corretto funzionamento del prodotto e può assicurare che l'acquario rimanga un ambiente salubre.

Girante e Albero motore

Per accedere alla girante e all'albero motore:

- ❶ Sollevare la leva del bocchettone per bloccare il flusso dell'acqua al filtro, estrarre il bocchettone dalla testate del filtro.
- ❷ Sganciare i 4 ganci per separare la testata dal corpo del filtro.
- ❸ Ruotare e rimuovere il tappo della girante che si trova sul lato inferiore della testata del filtro e rimuovere la girante e l'albero delicatamente.

Verificare le condizioni della girante e dell'albero motore e pulire con acqua proveniente dall'acquario. Pulire all'interno dell'alloggiamento della girante ed assicurarsi che le gomme dell'albero motore siano in posizione corretta ad entrambe le estremità prima di effettuare la sostituzione. Se la girante e l'albero motore presentano danni visibili contattare il rivenditore di zona per acquistare i pezzi di ricambio.



EF1 / EF2



EFX

Materiali filtranti

Si raccomanda di installare i materiali filtranti forniti nel seguente ordine: anelli in ceramica nel cestello inferiore, le bio balls nel cestello central e il carbone attivo nel cestello superiore.

Gli anelli in ceramica e le bio balls durano a lungo per cui possono essere sciacquati con acqua proveniente dall'acquario durante un comune ciclo di pulizia.

Si raccomanda di sostituire il carbone attivo almeno ogni 3-6 mesi.

DIAGRAMMA COMPONENTI

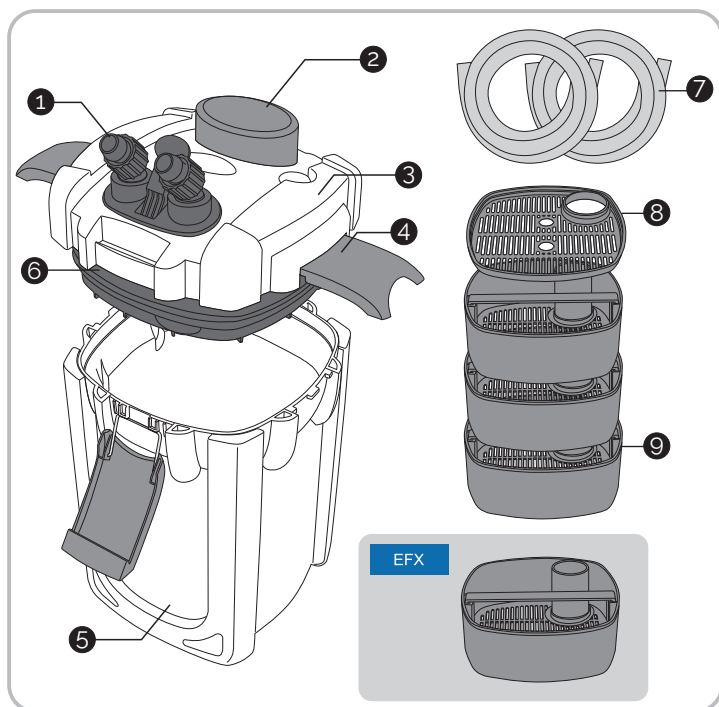

TUBATURA DI ENTRATA

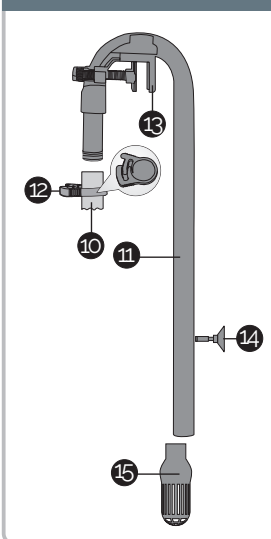

TUBATURA DI SVUOTAMENTO

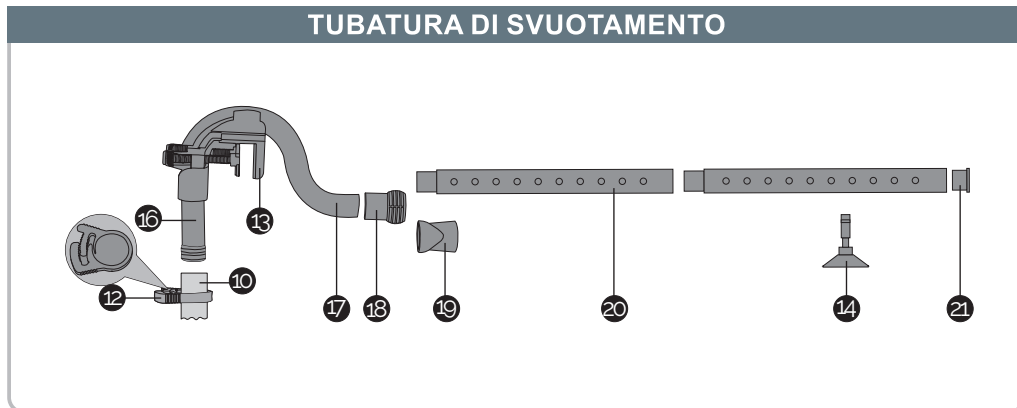

1	BOCCHETTONI DI ENTRATA/SVUOTAMENTO & GUARNIZIONI	6	GUARNIZIONE TESTATA	11	TUBO DI SOVRACCARICO PER PRESA ACQUA	16	TUBO DI SOVRACCARICO PER RITORNO DELL'ACQUA
2	PULSANTE DI INNESCO	7	FLESSIBILE (1.8m X 2)	12	CLIP DI FISSAGGIO DEL TUBO	17	TUBO DI SCARICO
3	TESTATA FILTRO	8	PIATTO BLOCCO MATERIALI FILTRANTI	13	MORSETTO DI FISSAGGIO VETRO	18	DADO DI USCITA
4	GANCI TESTATA/CORPO	9	CESTELLI MATERIALI FILTRANTI	14	VENTOSE	19	ADATTATORE DI USCITA - OPZIONALE ALLA BARRA SPRAY
5	CORPO FILTRO	10	TUBO VERDE	15	SKIMMER DI SUPERFICIE	20	BARRE DE SPRUZZATRICI
						21	TAPPO BARRA SPRUZZATRICE



Motore spento

- 1 Controllare che la presa di corrente sia connessa ed accesa.
- 2 Controllare che la girante sia installata correttamente, e che non sia danneggiata o bloccata.
- 3 Controllare che il cavo non sia danneggiato- se il danno è evidente staccare l'unità e non usare il filtro. Non provare ad effettuare riparazioni, ma consultare un elettricista o comunque del personale qualificato.
- 4 Sostituire il fusibile, se necessario.

Problemi di innesco

Se l'aria rimane bloccata nel sistema dopo la prima installazione, è necessario iniziare di nuovo il processo e seguire queste linee guida:

- 1 Controllare che i flessibili e le tubature siano connessi in modo corretto, chiusi ermeticamente e non vi siano strozzature.
- 2 Reinscrivere il bocchettone (1) per assicurarsi che sia installato saldamente e che sia possibile l'apertura (leva verso il basso).
- 3 Assicurarsi che i punti di connessione dei tubi di entrata e di svuotamento siano completamente immersi durante l'innesco.
- 4 Riempire il corpo del filtro (5) con acqua dell'acquario per favorire l'innesco del filtro.
- 5 Innescare il filtro EF con lo skimmer di superficie (15) staccato- sarà poi possibile riattaccarlo dopo l'innesco.
- 6 Assicurarsi che il corpo del filtro (5) non sia troppo pieno di materiali filtranti e schiuma, poiché questo potrebbe limitare il flusso dell'acqua ed inficiare la fase di innesco.

Rumore eccessivo

- 1 Assicurarsi che la girante del filtro sia installata in modo corretto, che non sia danneggiata e che non siano presenti strozzature.
- 2 Seguire le istruzioni della sezione ' Problemi d'innesco'.

Flusso d'acqua limitato

- 1 Assicurarsi che la girante del filtro sia installata in modo corretto, che non sia danneggiata e che non siano presenti strozzature.



- Controllare che i flessibili (7) e i tubi siano collegati in modo corretto, chiusi ermeticamente e non siano presentino strozzature.
- Controllare il corpo del filtro (5), i materiali filtranti, i flessibili (7) e i tubi per eventuali accumuli di rifiuti e pulire se necessario.

Altre domande?

Contattare il rivenditore del prodotto per ulteriore assistenza.

SPECIFICHE

MODEL	EF1	EF2	EFX
PORTATA	1000 L/H	1400 L/H	2000 L/H
DIAMETRO ESTERNO TUBO	20mm / 0.8"	20mm / 0.8"	25mm (1")
DIAMETRO INTERNO TUBO	15mm / 0.6"	15mm / 0.6"	18mm (0.7")
LUNGHEZZA TUBO	1.8 Metres x 2	1.8 Metres x 2	1.8 Metres x 2
VOLUME ACQUA	8 Litres (Approx)	12 Litres (Approx)	20 Litres (Approx)
ALTEZZA MASSIMA	1.4 Metres	2.0 Metres	2.5 Metres
VOLTAGGIO	220-240v	220-240v	220-240v
POTENZA ALIMENTAZIONE	24w	30w	45w
DIMENSIONE	395mm x 232mm x 232mm	440mm x 258mm x 258mm	490mm x 290mm x 290mm

ISTITUITO DIAGRAMMA

Water must be 1-2cm above inlet bend pipe

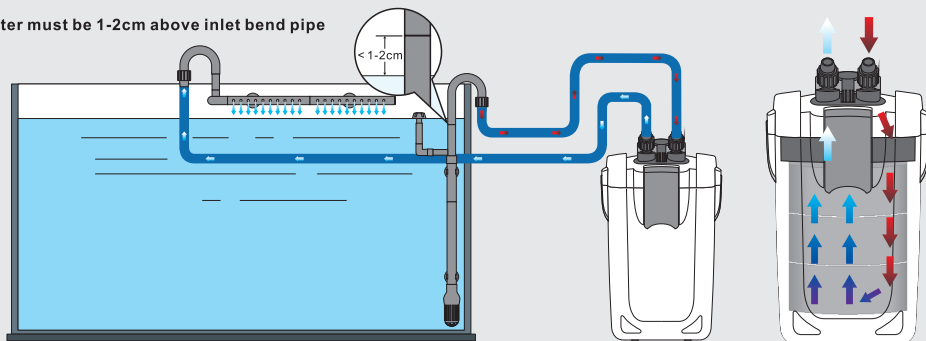

Position the EF adjacent to your fish tank for maximum flow

GARANZIA



La gamma di filtri All Pond Solutions è completa di una garanzia valida per 24 mesi a partire dalla data di acquisto in caso di guasto all'origine o difetto meccanico. L'azienda non si riterrà responsabile in caso di usura generale, danno accidentale o problemi derivanti da modifiche o uso improprio del prodotto. È possibile acquistare ricambi sul sito ufficiale o dal proprio rivenditore. Assicurarsi che vengano utilizzati componenti originali All Pond Solutions per la sostituzione o la riparazione.



¡IMPORTANTE! Desconecte el suministro de energía eléctrica antes de realizar cualquier instalación / mantenimiento o manipulación de cualquier tipo.

- El FE (Filtro Externo) nunca debe funcionar en seco ya que esto hará que la unidad se recaliente y cause un daño permanente.
- No intente modificar esta unidad en modo alguno y sólo utilice las piezas recomendadas para su sustitución.
- Todas las conexiones deben conectarse a tierra.
- No conectar a ningún otro voltaje que no sea el señalado.
- No utilizar con ningún otro líquido que no sea agua.
- No utilizar con agua por encima de 90F o 30C.

Por favor tenga en cuenta: Este artefacto puede ser utilizado por niños a partir de los 8 años y por personas con capacidades físicas, sensoriales o mentales reducidas o falta de experiencia y conocimiento si han sido supervisadas o instruidas acerca del uso del aparato de una manera segura y comprenden los peligros involucrados. Los niños no deben jugar con el artefacto. La limpieza y el mantenimiento no deben ser efectuados por niños sin supervisión.

ELECTRICIDAD

El FE viene con un suministro abundante de cable tripolar, sin embargo, si se necesitara un cable adicional es esencial el uso de un conector de cable impermeable aprobado.

- El suministro eléctrico debe estar conectado a tierra y con fusible de 3 amperios.
- Inspeccionar regularmente el cable en busca de daños y deterioro.
- Consulte con un electricista profesional si tiene dudas sobre cualquier aspecto del cableado.

- 1 Conecte el grifo del FE a la cabeza del filtro, tire hacia arriba del mango del grifo para permitir la inserción (1), empuje el grifo en el área de la cabeza del grifo (2), asegure el grifo en su lugar usando el mango del grifo (3).
- 2 Suelte los cuatro clips de la cabeza y cuerpo, y separe la cabeza del filtro del cuerpo del filtro.
- 3 Lave todo el material filtrante hasta que el agua salga limpia para evitar que libere exceso de polvo en su tanque. Llene el FE a $\frac{3}{4}$ de su capacidad con agua del acuario.
- 4 Vuelva a montar la cabeza del filtro al cuerpo del filtro.
- 5 Asegúrese de que todos cuatro clips de cabeza y cuerpo estén bien cerrados.
- 6 Compruebe que grifo del FE está cerrado para evitar fugas (palanca hacia abajo), y asegúrese de que su tubería está configurada de manera similar al diagrama de configuración debajo.
- 7 Prepare el FE presionando el botón de cebado, presione el botón con la palma de su mano y mantenga presionado hasta que todos los tubos estén llenos de agua.
- 8 Encienda el FE en la fuente de alimentación.

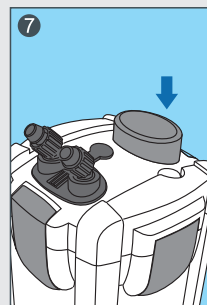
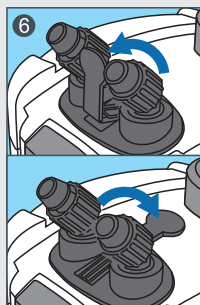
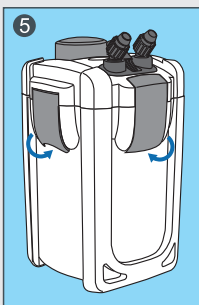
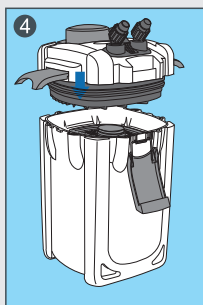
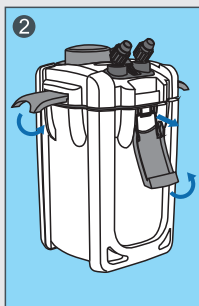
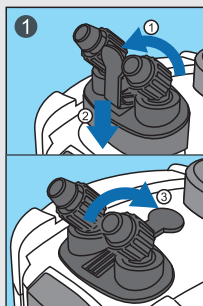

Recomendamos que siga un programa de limpieza y mantenimiento regular para asegurar el bienestar de los peces. Dependiendo del volumen de agua y niveles de inventario, la limpieza habitual de los materiales de filtración, espumas, impulsor, tuberías de entrada / salida durante un cambio de agua del 10 al 25% ayudará a asegurar que el producto funciona de manera eficiente y el acuario permanece saludable.

Impulsor y Eje

Para acceder al impulsor y eje:

- 1 Levante el mango del grifo FE para cerrar el flujo de agua al FE, separe el grifo FE de la cabeza del filtro.
- 2 Suelte los cuatro clips de la cabeza y cuerpo y separe la cabeza del filtro del cuerpo del filtro.
- 3 Gire y retire la tapa del impulsor situado en la pieza inferior de la cabeza del filtro y extraiga suavemente el impulsor y el eje.

Compruebe el estado del impulsor y el eje y limpie utilizando agua de su acuario. Limpie el interior de la carcasa del impulsor y asegúrese de que los cauchos del eje están en su lugar en ambos extremos antes de volver a ponerlo. Si el impulsor y el eje tienen daños visibles, contacte a su vendedor local para comprar reemplazos. Revertir los pasos anteriores para reemplazar.



EF1 /EF2



EFX

Material Filtrante

Se recomienda instalar los materiales filtrantes suministrados en el siguiente orden: anillos de cerámica en la canasta inferior, bolas bio en la canasta media y carbón activado en la canasta superior.

Anillos de cerámica y Bolas Bio son materiales duraderos y pueden enjuagarse con agua de acuario como parte de un programa de limpieza periódica. Recomendamos sustituir el carbón activado al menos cada 3-6 meses.



DIAGRAMA DE PIEZAS

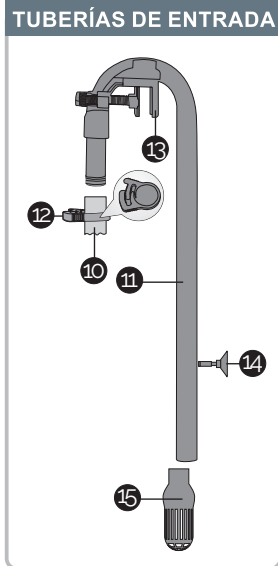
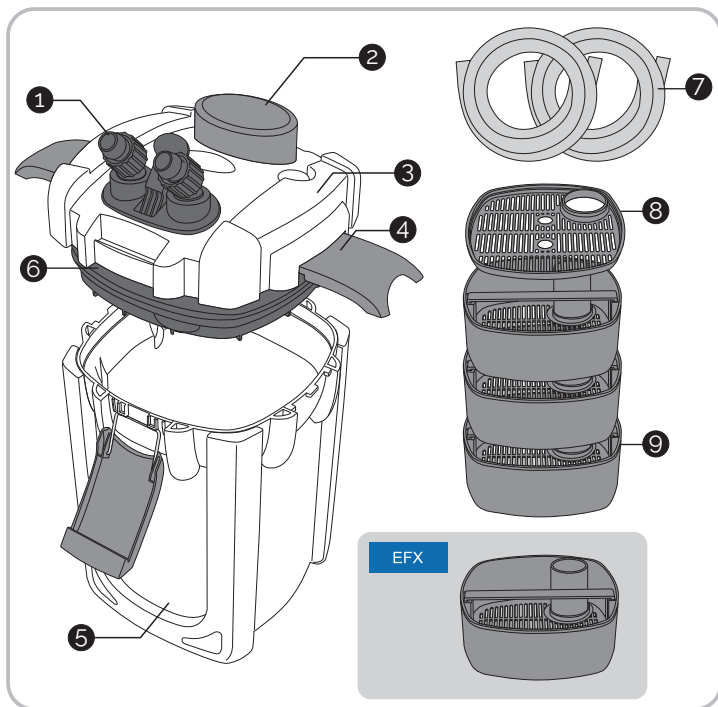

TUBERÍAS DE SALIDA

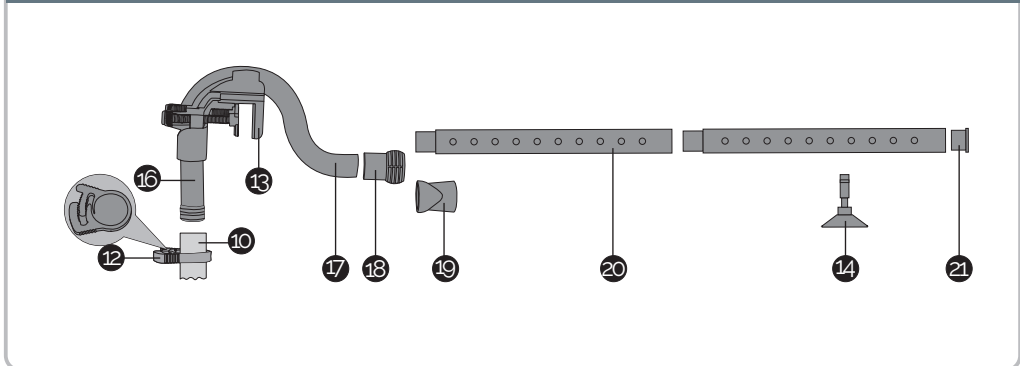

1	GRIFO Y ANILLOS-O DE ENTRADA/SALIDA	6	ANILLO-O DE CABEZA	11	TUBO DE DESAGÜE PARA ENTRADA DE AGUA	16	TUBO DE DESAGÜE PARA RETORNO DE AGUA
2	BOTÓN DE CEBADO	7	MANGUERA (1.8M X 2)	12	SOPORTE DE BLOQUEO PARA MANGUERA	17	TUBO DE SALIDA
3	CABEZA DEL FILTRO	8	PLACA ASEGURADORA DE MATERIAL	13	ABRAZADERA PARA VIDRIO	18	TUERCA DE SALIDA
4	CLIPS DE CABEZA / CUERPO	9	CANASTA DE MATERIAL FILTRANTE	14	VENTOSAS	19	ADAPTADOR DE SALIDA - OPERACIONAL PARA BARRA DE ROCIADO
5	CUERPO DEL FILTRO	10	MANGUERA VERDE	15	COLADOR	20	BARRA DE ROCIADO
						21	TAPA PARA BARRA DE ROCIADO



El Motor No Funciona

- 1 Verifique que el suministro de energía está conectado y encendido.
- 2 Verifique que el impulsor está instalado correctamente, en buen estado y no hay obstrucción.
- 3 Verifique que el cable no está dañado – si hay daño evidente, desconecte la unidad y no utilice el FE. No intente reparar, consulte a un electricista u otra persona capacitada.
- 4 Cambie el fusible si es necesario.

Problemas de Cebado

Si el aire queda atrapado en el sistema después de la instalación inicial, por favor reinicie el proceso y siga estas pautas:

- 1 Verifique que todas las mangueras y tuberías están conectadas correctamente, de forma hermética y sin restricciones.
- 2 Vuelva a insertar el grifo de Entrada / Salida (pieza 1) para asegurarse de que esté bien instalado y configurado para abrir (palanca hacia abajo).
- 3 Asegúrese de que todos los puntos de conexión de la tubería de Entrada / Salida están totalmente sumergidos durante el cebado.
- 4 Llene el cuerpo del filtro FE (pieza 5) con agua de acuario, esto ayudará al cebado del FE.
- 5 Bebe el FE sin la espumadera de superficie (pieza 15) unida — se puede volver a conectar después del cebado.
- 6 Asegúrese de que el cuerpo del filtro (pieza 5) no está abarrotado con materiales y espuma ya que esto puede restringir el flujo del agua y afectar la función de cebado.

Ruido Excesivo

- 1 Asegúrese de que el impulsor está instalado correctamente, en buen estado y sin obstrucción.
- 2 Siga la solución de problemas de 'Problemas de Cebado' arriba.

Flujo de Agua Restringido

- 1 Asegúrese de que el impulsor del FE está instalado correctamente, en buen estado y sin obstrucción.
- 2 Verifique que todas las mangueras (pieza 7) y tuberías están conectadas correctamente, de forma hermética y sin restricciones.



- 3 Verifique que en el cuerpo del filtro FE (pieza 5), materiales de filtrado, mangueras (pieza 7) y todas las tuberías no haya acumulación de residuos restrictiva y limpie si fuera necesario.

¿Aún tiene problemas?

Póngase en contacto con el vendedor a quien le compró este producto All Pond Solutions para que le brinde ayuda adicional.

ESPECIFICACIONES

MODEL	EF1	EF2	EFX
CAUDAL	1000 L/H	1400 L/H	2000 L/H
DIÁMETRO MANGUERA EXTERIOR	20mm / 0.8"	20mm / 0.8"	25mm (1")
DIÁMETRO MANGUERA INTERIOR	15mm / 0.6"	15mm / 0.6"	18mm (0.7")
LONGITUD DE LA MANGUERA	1.8 Metres x 2	1.8 Metres x 2	1.8 Metres x 2
VOLUMEN DE AGUA	8 Litres (Approx)	12 Litres (Approx)	20 Litres (Approx)
ALTURA MÁXIMA	1.4 Metres	2.0 Metres	2.5 Metres
VOLTAJE	220-240v	220-240v	220-240v
POTENCIA	24w	30w	45w
DIMENSIONES	395mm x 232mm x 232mm	440mm x 258mm x 258mm	490mm x 290mm x 290mm

CREAR DIAGRAMA

Water must be 1-2cm above inlet bend pipe

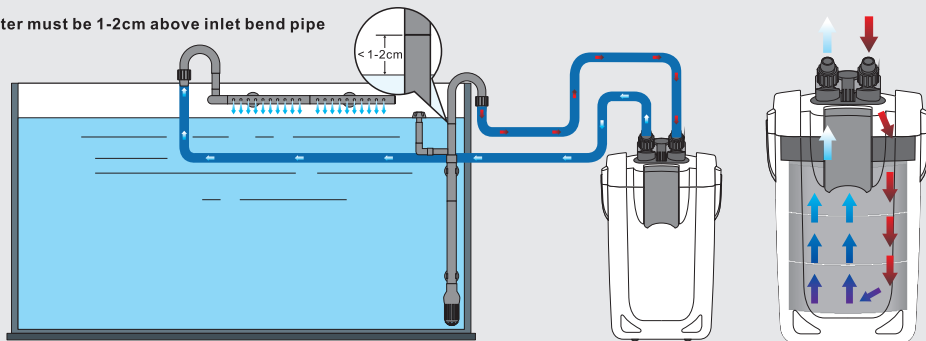

Position the EF adjacent to your fish tank for maximum flow

GARANTÍA



La gama de FE All Pond Solutions se suministra con una garantía que garantiza las piezas en el caso de una falla genuina o una falla mecánica durante 24 meses a partir de la fecha de compra. No aceptamos responsabilidad por desgaste, daño accidental o problemas derivados de la modificación o mal uso. Las piezas de repuesto están disponibles en nuestro sitio web oficial o de su proveedor local. Por favor, asegúrese que solo se utilizan componentes All Pond Solutions genuinos al efectuar un reemplazo o reparación.



ACHTUNG! Trennen Sie das Gerät vom Stromnetz vor der Installation, Aufrechterhaltung oder Behandlung des Geräts.

- Der EF Filter darf nicht trocknen lassen, da es dabei überhitzt und beschädigt.
- Versuchen Sie nicht das Gerät in keiner Weise zu ändern und nur die empfohlenen Ersatzteile verwenden.
- Alle Anschlüsse müssen geerdet sein.
- Verwenden Sie keine andere Spannung.
- Verwenden Sie mit keinen anderen Flüssigkeiten als Wasser
- Nutzen Sie nicht mit Wasser ab einer Temperatur von 90F / 30C.

Zur Beachtung: Dieses Gerät ist für die Verwendung durch Personen vorgesehen (Kinder über 8 Jahre alt eingeschlossen), die verminderte körperliche, sensorielle oder geistige Fähigkeiten haben oder nicht über ausreichende Erfahrung und Kenntnisse verfügen, ausser sie haben von einer Person, die für ihre Sicherheit verantwortlich ist, Anweisungen für den Gebrauch des Geräts erhalten oder werden von dieser beaufsichtigt. Kinder sollten beaufsichtigt werden, um sicherzustellen, dass sie nicht mit dem Gerät spielen. Die Reinigung und Pflege des Geräts dürfen nicht von Kinder ohne Aufsicht aufgeführt.

ELEKTRISCH

Der EF Aussenfilter enthält 3 Kabel. Falls zusätzlichen Kabel erforderlich ist, brauchen Sie ein bewährte wasserfestes Kabel

- Die Stromversorgung muss geerdet sein und mit 3 Ampere gesichert.
- Regelmässig Netzkabel auf Schäden und Verschleiss prüfen.
- Im Zweifelsfall fragen Sie Ihren Elektroinstallateur

- ❶ Machen Sie der EF Wasserhahn auf dem Filterkopf. Ziehen Sie dem Zapfhebel um ein Stecken zulassen (1) drücken Sie der Wasserhahn in den Luftspaltbereich (2), befestigen Sie den Wasserhahn mit dem Zapfhebel (3).
- ❷ Binden Sie alle Karosseriekammer los und trennen Sie der Filterkopf von den Filterkörper.
- ❸ Waschen Sie alle die Filtermedien so lange bis das Wasser klar ist, um kein Überschusspulver und Staub im Tank zu haben. Der EF Filter mit Aquarienwasser drei Viertel füllen.
- ❹ Bauen Sie der Filterkopf mit dem Filterkörper wieder zusammen.
- ❺ Stellen Sie sicher, dass die vier Karosseriekammer gut verschlossen sind.
- ❻ Stellen Sie sicher, dass der EF Wasserhahn verschlossen ist, um Auslaufen zu vermeiden. Der Zapfhebel muss nach unten sein. Die Verrohrung muss korrekt aufgebaut werden (sie folgende Abbildung).
- ❼ Drücken Sie auf dem Knopf, um das Gerät bereit zu machen. Drücken Sie mit der flachen Hand auf dem Knopf, bis zur alle Wasserleitungen sind voll mit Wasser.
- ❽ Schalten Sie das Gerät an an der Stromquelle.

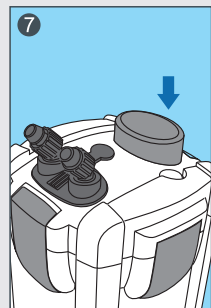
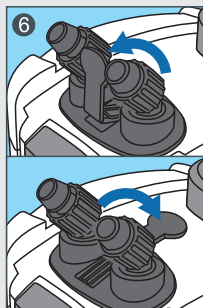
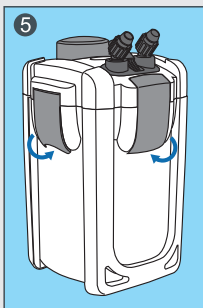
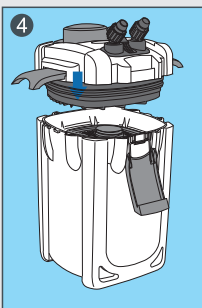
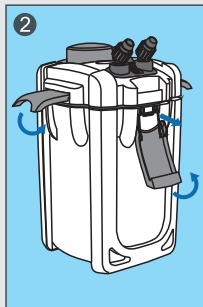
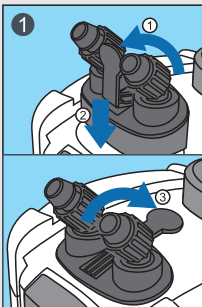

Wir empfehlen die regelmässige Reinigung und Aufrechterhaltung um verantwortungsvolle Aquaristik sicherzustellen. Je nach Wasserdurchflussmenge und Bevorratungsebene muss man die Filtermedien, Schäume, Laufrad, und Eingangs- und Ausgangsrohrleitungen während eine 10-25% Wasserwechsel reinigen um die Effizienz des Produkts zu sichern und dass das Aquarium gesund bleibt.

Laufrad und Welle

Zugang zum Laufrad und Welle:

- 1 Ziehen Sie der Wasserhahn um das Wasserdurchfluss zu den EF zu stoppen. Ziehen Sie der EF Wasserhahn weg von den Filterkopf.
- 2 Binden Sie alle Karosseriekammer los und trennen Sie der Filterkopf von den Filterkörper.
- 3 Drehen Sie die Luftradhut, die unter dem Filterkopf liegt und ziehen Sie die Luftrad und Welle ab.

Überprüfen Sie den Zustand des Laufrads und Welles. Reinigung mit Aquarienwasser. Reinigen Sie im Laufrad. Bevor der Ersatz checken Sie die Wellekautschuke an Beiden enden eingerastet sind.

Wenn das Laufrad und Welle sichtbare Schäden haben, kontaktieren Sie ihr örtliche Händler damit Sie Ersatzteile kaufen können.



EF1 /EF2



EFX

Filtermedien

Zur Installation der gelieferte Filtermedien empfehlen wir im Folgenden: Keramikringe in den untere Korb, Biobälle in den mittlere Korb und Aktivkohle in den obere Korb.

Keramikringe und Bio Kugeln werden lang anhaltende Medien und kann gespült werden, Reinigen mit Aquarienwasser als Teil eines regelmäßigen Reinigungsplan .

Wir empfehlen einenen Aktivkohle wechsel nach immer 3-6 Monate.

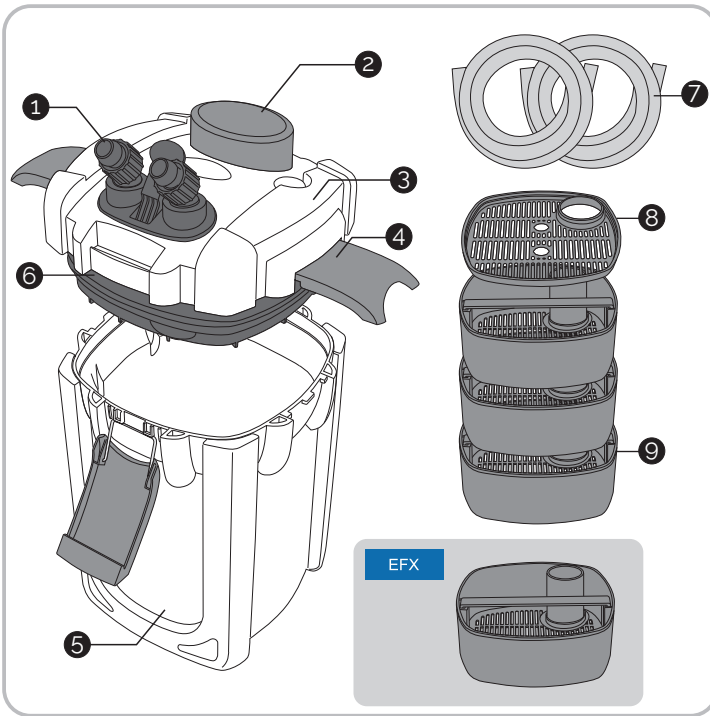

INNENROHRLEITUNGEN

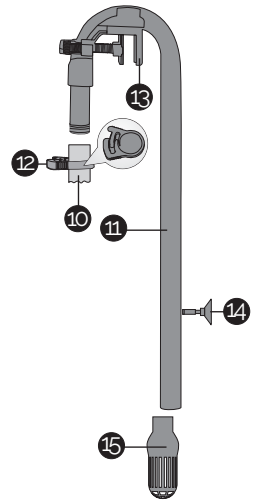

AUSSENROHRLEITUNGEN

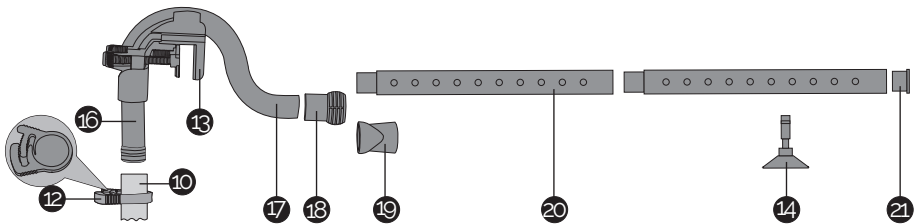

1	INNEN-UND AUSSENROHRLEITUNGEN O-RINGE	6	HAUPT O-RING	11	ÜBERLAUFROHR FÜR WASSERAUFNAHME	16	ÜBERLAUFROHR FÜR WASSER RÜCKGABE
2	KNOFF	7	SCHLAUCH (1.8MX2)	12	SCHLAUCHBEFESTIGUNGSKLAMMER	17	AUSLASSROHR
3	FILTERKOPF	8	MEDIENGESICHERTE TELLER	13	GLASBEFESTIGUNG SKLEMME	18	AUSGANGSMUTTER
4	KAROSSERIE-KLAMMER	9	FILTERKÖRBE	14	SAUGNÄPFE	19	OUTLET ADAPTER - OPTIONAL FÜR SPRAY BAR
5	FILTERKÖRPER	10	GRÜNER SCHLAUCH	15	SAUGKORB	20	SPRITZRAMPE
						21	SPRITZRAMPE ENDKAPPE



Kein Motor In Betrieb

- 1 Verbinden Sie das Stromversorgung und schalten Sie das Strom an.
- 2 Checken Sie auf das korrekte Installation von einem unbeschädigte, frei von Blockierungen Laufrad.
- 3 Kabel auf Beschädigung überprüfen gegebenenfalls das Gerät vom Strom entfernen und nutzen Sie nicht den EF. Versuchen Sie nicht das Gerät zu reparieren. Wenden Sie sich an einen Elektriker.
- 4 Sicherung ersetzen.

Vorbereitungsprobleme

Wenn es Luft im System gibt nach Abschluss der Einrichtung, bitte wiederholen Sie die Schritte mit den folgenden Richtlinien:

- 1 Alle Verschlauchung und Rohrleitungen muss korrekt, luftdicht und frei verbunden sein.
- 2 Führen Sie wieder die Innen- und Aussenrohrleitungen (Teil 1) ein um eine sichere Installation sicherzustellen und Ziehen Sie der Hebel nach unten (anmachen).
- 3 Checken Sie die das Untertachen alle Innen- und Aussenrohrleitungen während der Vorbereitung.
- 4 Füllen Sie der EF Filterkörper (Teil 5) mit Aquarienwasser um der Vorbereitung der EF zu helfen.
- 5 Bereiten Sie der EF vor, ohne den angehängte Oberflächenabsauger (Teil 15). Es kann nach dem Vorbereitung wieder zusammengeführt.
- 6 Checken Sie, der EF Filterkörper nicht überfüllt mit Medien und Schäume ist, weil es der Wasserdurchfluss beschränken könnte.

Übermässiges Geräusch

- 1 Stellen Sie sicher, das EF Laufrad korrekt installiert und ganz unbeschädigt ist ohne Risiko von Blockierung.
- 2 Beachten Sie auf die Fehlersuche Vorbereitungsprobleme oben.

Restricted Water Flow

- 1 Stellen Sie sicher, das EF Laufrad korrekt installiert und ganz unbeschädigt ist ohne Risiko von Blockierung.



- 2 Alle Verschlauchung (Teil 7) und Rohrleitungen muss korrekt, luftdicht und frei verbunden sein.
- 3 Checken Sie der EF Filterkörper (Teil 5), Fitermedien, Verschlauchung (Teil 7) und alle Rohrleitungen für eine Sammlung beschränkende Abfälle und bei Bedarf reinigen.

Haben Sie immer noch Probleme?

Zur Unterstützung, bitte setzen Sie mit ihrem zuständigen Händler in Verbindung.

SPEZIFIKATIONEN

MODEL	EF1	EF2	EFX
ABFLUSSMENGE	1000 L/H	1400 L/H	2000 L/H
SCHLAUCHAUSSENDURCHMESSER	20mm / 0.8"	20mm / 0.8"	25mm (1")
SCHLAUCHINNENDURCHMESSER	15mm / 0.6"	15mm / 0.6"	18mm (0.7")
SCHLAUHLÄNGE	1.8 Metres x 2	1.8 Metres x 2	1.8 Metres x 2
WASSERMENGE	8 Litres (Approx)	12 Litres (Approx)	20 Litres (Approx)
MAX. HÖHE	1.4 Metres	2.0 Metres	2.5 Metres
SPANNUNG	220-240v	220-240v	220-240v
KRAFT	24w	30w	45w
ABMESSUNGEN	395mm x 232mm x 232mm	440mm x 258mm x 258mm	490mm x 290mm x 290mm

EINRICHTEN DIAGRAMM

Water must be 1-2cm above inlet bend pipe

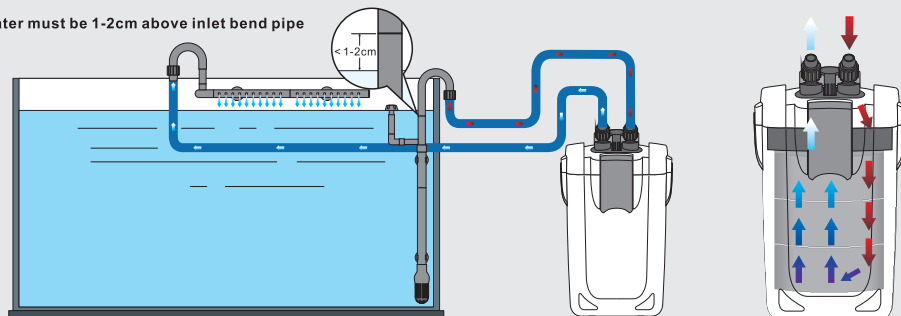

Position the EF adjacent to your fish tank for maximum flow

GARANTIE



Die All Pond Solutions EF Reihe ist mit einer Garantie von 24 Monate nach dem Kauf im Falle eines Ausfalls der mechanischen Anlagen geliefert. Für natürlichen Verschleiss oder natürliche Abnutzung wird keine Mängelhaftung übernommen. Ersatzteile sind von unsere Webseite oder ihrem zuständigen Händler verfügbar. Bitte beachten Sie auf nur ausschliessliche Original Komponenten während einem Ersatz oder einer Reparatur.



www.allpondsolutions.co.uk

All Pet Solutions Limited Trading as All Pond Solutions
Unit 203 Riverside Way, Uxbridge, Middlesex,
England, UB8 2YF